

QUICK-START GUIDE

NUMARK NS6

serato



Installation and Setup

The Numark NS6 requires drivers for both Mac and Windows. You will find these on the installation CD that is provided with your Numark NS6, or go to <http://serato.com/dj/support>

NOTE: Please ensure you have the latest available drivers AND firmware updates, which may be required in order to be compatible with Serato DJ. Please go to <http://serato.com/dj/support>

1. Download and install the latest version of Serato DJ from <http://serato.com/dj/downloads>
2. Connect your Numark NS6 to an available USB Port.
3. Open Serato DJ.

NOTE: The Numark NS6 does not require a Serato DJ license purchase. When you first download Serato DJ you will see a license panel appear on the right hand side.

Simply tick the box DO NOT SHOW AGAIN in the bottom right hand corner, then click on **Online** which will hide this panel. Serato DJ will remember these settings for when you next open the software.

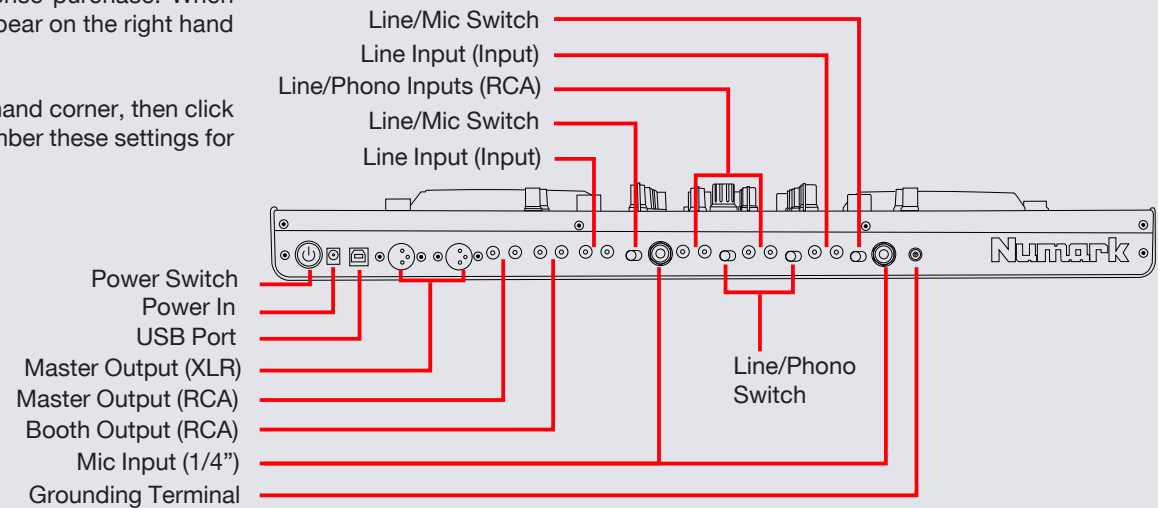
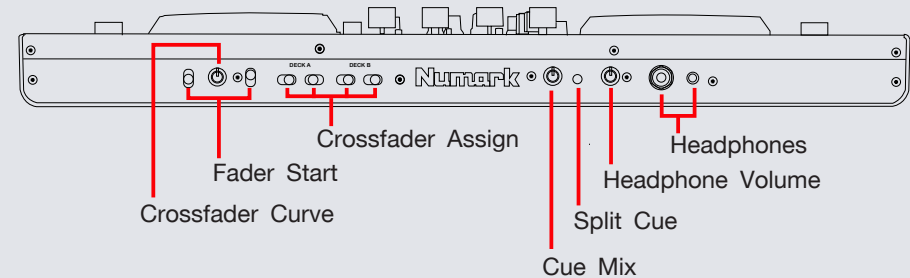

Looping

You have the choice of Auto or Manual Looping within Serato DJ with the Numark NS6.

NOTE You can also save a loop to the next available free loop slot in the software. To do this, click  on an available loop slot. Your loops are saved to the file and recalled the next time it is loaded. They are not lost if the file is moved or renamed.



Numark NS6	Manual Loop Mode	Auto Loop Mode	Shift
1/2 X	Half Loop Length		
2 X	Double Loop Length		
ON/OFF	Loop On/Off		
LOOP SHIFT <	Loop Shift Left		
LOOP SHIFT >	Loop Shift Right		
MANUAL/AUTO LOOP	Toggles between Manual & Auto Loop Modes		
IN/1	Set loop in point (Loop not active)/Adjust loop in point (Loop active)	1 Bar Autoloop On/Off	1/16 Loop Roll
OUT/2	Set loop out point (Loop in point set)/Adjust loop out point (Loop active)	2 Bar Autoloop On/Off	1/8 Loop Roll
SELECT/4	Scroll to Select Saved Loops	4 Bar Autoloop On/Off	1/4 Loop Roll/Clear selected loop slot (manual mode)
RELOOP/8	Reloop (Activates & Jumps to Loop)	8 Bar Autoloop On/Off	1/2 Loop Roll

NOTE The best way to edit the start and end points of a manual loop is with the jog wheel/platter on your Numark NS6.

DJ-FX

The DJ-FX in Serato DJ are powered by iZotope. Click the FX tab  to open the FX panel. Select either 1, 2, 3, 4 or M to assign the selected effect bank to a deck or Master Output.

There are two available modes in the DJ-FX. Single FX Mode allows you to select one effect per FX bank, and has multiple parameters that can be adjusted. Multi FX Mode allows you to select up to three effects per FX bank, and adjust only one parameter, the FX Depth. The same effects available in Single FX mode are available in Multi FX mode, as well some additional presets. In the FX panel. Select either 1, 2, 3, 4 or M to assign the selected effect bank to a deck or Master Output.

You can select between the two FX modes by clicking either the Single FX mode button  or Multi FX mode button 

Numark NS6 Control	Single FX Mode	Shift
FX A/B (Button)	Effect On/Off	Adjust FX Parameter 2
FX MIX (Slider)	Adjust FX Parameter 1	
FX PARAMETER (knob)	Adjust FX Parameter 3	Adjust FX Parameter 5
FX SELECT	Adjust Beats Multiplier/Tap to the desired FX tempo. To return to AUTO mode, press and hold	Select Effect

Numark NS6 Controls	Multi FX Mode	Shift

FX A/B (Button)	Effect Slot 1 On/Off	Effect Slot 2 On/Off
FX MIX (Slider)	Effect Slot 1 Depth	
PARAMETER (knob)	Effect Slot 2 Depth	Effect Slot 3 Depth
FX SELECT (knob)	Adjust Beats Multiplier/Tap to the desired FX tempo. To return to AUTO mode, press and hold	Select Effect Slot 1

Serato Video

Serato Video is a software plugin for Serato Software which adds the ability to playback and mix video files, use effects and fader transitions with your Serato DJ Controller, an additional MIDI controller or your mouse/keyboard.

For More information on Serato Video go to <http://serato.com/video>

MIDI

The MIDI control feature in Serato DJ provides the ability to map Serato DJ software functions to MIDI controller functions such as keyboards, triggers, sliders, and knobs. Integrating MIDI controllers into your Serato DJ setup can improve live performance usability, such as hitting pads on a MIDI controller to trigger Loops and Cue Points.

For more information download the Serato DJ manual by going to <http://serato.com/dj/downloads>

NOTE: You can not MIDI Map your Mixtrack Pro, you will need to connect an additional MIDI controller to use these MIDI functions.

serato



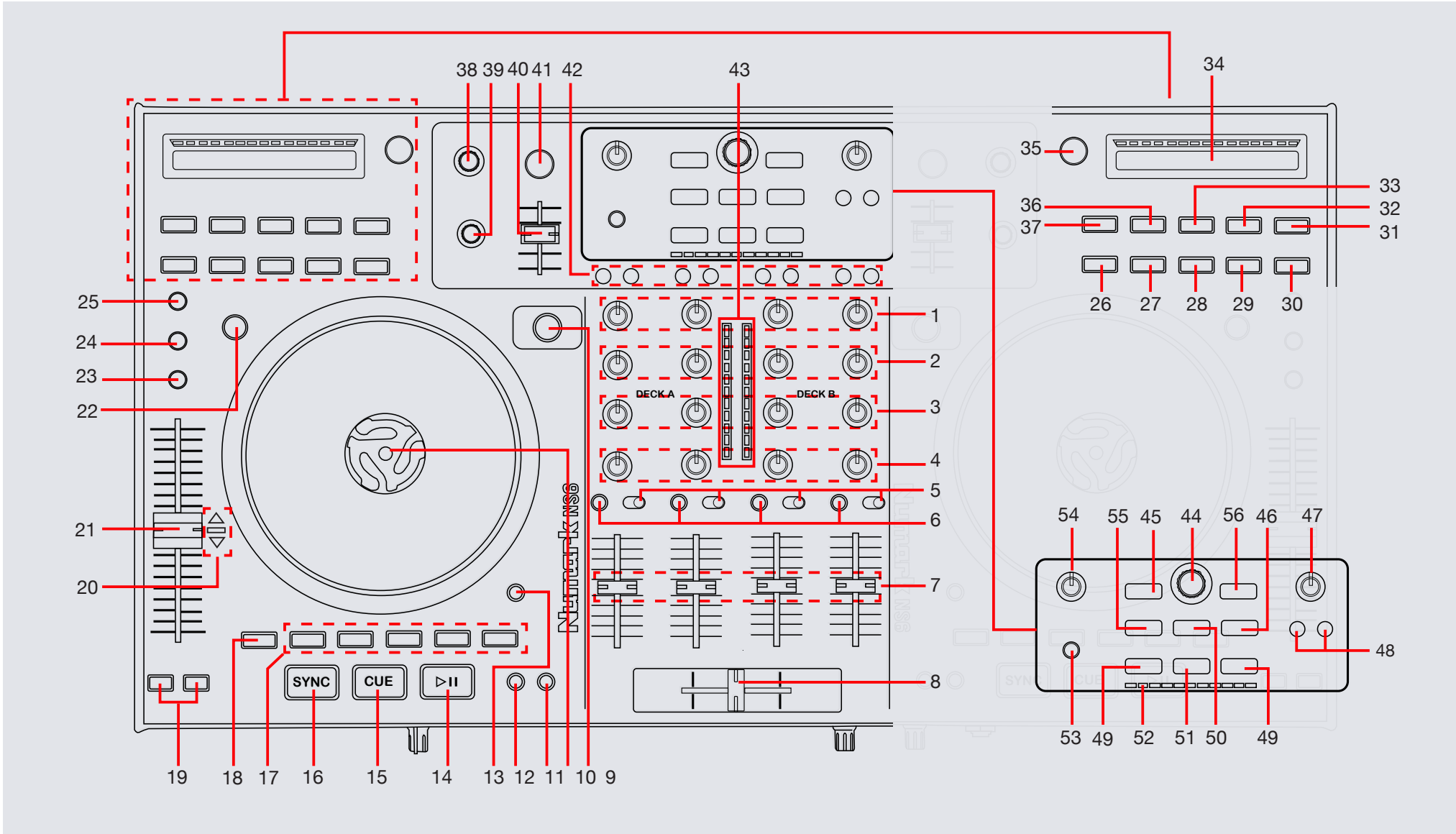

NOTE: SHIFT button is used with other buttons that have shift modifier functions.

#	Numark NS6	Function	Shift
1	GAIN	Adjusts the gain for each channel	
2	TREBLE	Adjusts the HI for each channel	
3	MID	Adjusts the MID for each channel	
4	LOW	Adjusts the LOW for each channel	
5	INPUT SELECTOR	Select audio source from this channel - "PC" or "LINE/MIC" or "LINE/PHONO"	
6	PFL	Cue selected channel in headphones	
7	CHANNEL FADER	Adjusts channel volume	
8	CROSSFADER	Crossfades the output sound between the two selected decks	
9	LAYER	Selects which layer in the software is controlled by that hardware Deck. Deck A can control Layer 1 or 3; Deck B can control Layer 2 or 4	
10	PLATTER	Scratch (SCRATCH On) Jog (SCRATCH Off)	Beat Skip
11	ADJUST/SLIP	Move Platter while holding ADJUST to Adjust Beatgrid	Move Platter while holding SHIFT + SLIP to Slip Beatgrid
12	CLEAR/SET	Set Beatgrid Downbeat Marker	Clear Beatgrid
13	SKIP	Beat Skip	
14	PLAY/PAUSE	Play/Pause	Stutter Play
15	CUE	Add/Trigger Temporary Cue	Jump to start of track (more than 2 Sec elapsed) Previous track (less than 2 sec elapsed)
16	SYNC	Sync On	Sync Off (Press twice to return to Absolute Pitch when in Relative Mode)

#	Numark NS6	Function	Shift
17	CUE (1-5)	Add/Trigger Cuepoint 1-5	Add/Trigger Cuepoint 1-5
18	SHIFT/DELETE	SHIFT button is used with other buttons that have shift modifier functions	
19	PITCH BEND	Pitch bend up or down	
20	TAKEOVER LEDs	When switching deck layers, the position of the PITCH FADER may not match the Pitch setting for that Deck in Serato DJ. Slowly move the PITCH FADER in the direction indicated by the TAKEOVER LED arrow until it turns off. At this point, the PITCH FADER matches the Pitch setting in Serato DJ	
21	TEMPO FADER	Adjust Tempo, An LED next to the fader will light up when set at 0%	When in Sync mode, used to disable the Pitch Fader temporarily and change the zero position
22	SCRATCH	Press this to turn Scratch Mode on/off. When in Scratch Mode, the button will be lit, and moving the PLATTER will scratch the track. When not in Scratch Mode, moving the PLATTER will bend the track's pitch	Activate Slip
23	RANGE	Cycle through available Tempo Ranges	
24	KEYLOCK	Keylock On/Off	
25	BLEEP/REVERSE	Reverses audio playback	Censor
26	MODE	Toggles between Manual and Auto Loop Modes	
27	IN/1	Set loop in point (Loop not active)/Adjust loop in point (Loop active)/1 Bar Autoloop On/Off (Auto Mode)	1/16 Loop Roll
28	OUT/2	Set loop out point (Loop in point set)/Adjust loop out point (Loop active)/2 Bar Autoloop On/Off (Auto)	1/8 Loop Roll
29	SELECT/4	Cycle through stored Loops/4 Bar Autoloop On/Off (Auto)	1/4 Loop Roll/Clear selected loop slot (manual mode)
30	RELOOP/8	Reloop (Activates & Jumps to Loop)/8 Bar Autoloop On/Off (Auto)	1/2 Loop Roll
31	LOOP SHIFT >	Loop shift left	
32	LOOP SHIFT <	Loop shift right	
33	ON/OFF	Loop On/Off	

#	Numark NS6	Function	Shift
34	STRIP SEARCH	The length of this strip represents the length of the entire track. Place your finger on a point along this sensor to jump to that point in the track	
35	TAP	Tap this button at the same tempo as the track to edit the BPM. Press and hold to save BPM.	
36	1/2 X	Halve Auto Loop Length	
37	2 X	Double Auto Loop Length	
38	FX PARAMETER	Effect Slot 2 Depth	Effect Slot 3 Depth
39	FX SELECT	Adjust Beats Multiplier/Tap to the desired FX tempo. To return to AUTO mode, press and hold	Select Effect Slot 1
40	FX MIX	Effect Slot 1 Depth	
41	FX A/B	Effect Slot 1 On/Off	Effect Slot 2 On/Off
42	FX SEND	Use these buttons to apply Effect A and/or B to the corresponding channel. You can apply Effect A and/or B to the entire Program Mix by using the FX SEND buttons below the MASTER VOLUME knob.	
43	LED METERS	Monitors the audio levels of the Master Output	
44	SCROLL KNOB	Scroll through currently focused area (library/crates/etc)	
45	FWD	Toggles focus between library/crates/open panels	Sort library by Album
46	FILES	Press this to move the selector to the Files Panel	Sort library by BPM
47	MASTER	Adjust Master Output	
48	MASTER FX A/B	Assign FX UNIT 1/2 to Master Output	
49	LOAD A / B	Load track to selected deck	
50	PREPARE	Press this to move the selector to the Prepare Panel	Sort library by Artist
51	LOAD PREPARE	Press this to add a selected track to the list of tracks in the Prepare Panel in the software	

#	Numark NS6	Function	Shift
51	LOAD PREPARE	Press this to add a selected track to the list of tracks in the Prepare Panel in the software	
52	BPM METER	This meter is an aid for matching the tempo of both decks. When the white center LED is lit, the BPMs are matched. Otherwise, the meter will tend towards the faster deck. The further from center, the greater the difference between the two BPMs.	
53	VIEW	Cycle view modes	
54	BOOTH/ZONE	Adjust Booth Output	
55	CRATES	Press this to move the selector to the Crates Panel	Sort library by Song
56	Back	Navigate Back	

Using the Tool Tips

Click on the  icon to enable Tool Tips. This is located in between the MIDI and setup button in the top right hand corner of the screen.

Tool Tips provide a handy way to learn the various features of Serato DJ.

Move the mouse over a section of the screen to bring up a context sensitive tool tip. Holding the mouse over the  button with Tool Tips turned on will show you a list of all keyboard shortcuts.

For more information about how to use Serato DJ, please go to our website www.serato.com or refer to the Serato DJ Software Manual. For more information on your controller, please refer to the hardware manual.

If you have any questions, please contact support@serato.com or go to www.serato.com/dj/support

serato

